

BIOSAFE mechanical basin mixer

Ref. 26216

Single hole mechanical mixer with no spout H. 95mm L. 110mm





DESCRIPTION

BIOSAFE mechanical basin mixer - Ref. 26216





Deck-mounted mechanical basin mixer
 Single hole mechanical mixer H. 95mm L. 110mm.
 No spout: hygienic flow straightener integrated into the body.
 Securitouch thermal insulation prevents burns.
 Ø 35mm ceramic cartridge with pre-set maximum temperature limiter.
 Thermal shocks are possible without removing the control lever or shutting off the cold water supply.
 Body with smooth interior and very low water volume (reduces bacterial development).
 Flow rate regulated at 5 lpm.
 Solid control lever.
 No pop-up waste.
 Mixer with copper tails and stopcocks Ø 15mm.
 Fixing reinforced by two stainless steel rods.
 Mechanical mixer ideal for healthcare facilities, retirement and care homes, hospitals and clinics.
 Single hole mixer suitable for people with reduced mobility.
 Mixer with 30-year warranty.
 Also available with PEX flexibles.

TECHNICAL CHARACTERISTICS

BIOSAFE mechanical basin mixer - Ref. 26216

| | |
|---------------------|---|
| Connector | 1/2" |
| Technology | BIOSAFE mechanical mixer |
| Height | 180mm |
| Length | 220mm |
| Drop height | 95mm |
| Spout length | 110mm |
| Flow rate | 4 lpm |
| Temperature limiter | Yes |
| Finish | Chrome-plated brass |
| Norms |  |
| Warranty |  |

ADVANTAGES

-  Hygiene: body with very low water volume
-  Maximum hygiene: mixer with no spout
-  Thermal shocks are possible without removing lever
-  Pre-set maximum temperature limiter

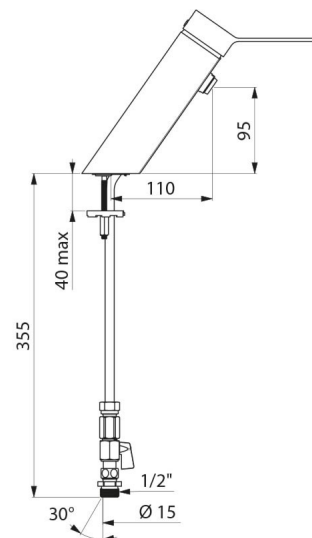

Repairability

