

# SECURITHERM EP BIOSAFE pressure-balancing basin mixer

Ref. 2620MINIEP

Single hole mechanical mixer with no spout H. 50mm L. 80mm





## DESCRIPTION

**SECURITHERM EP BIOSAFE pressure-balancing basin mixer - Ref. 2620MINIEP**

Deck-mounted mechanical basin mixer with pressure-balancing. Single hole mechanical mixer H. 50mm L. 80mm. No spout: hygienic flow straightener integrated into the body. Ø 35mm ceramic cartridge with pressure-balancing and pre-set maximum temperature limiter. Anti-scalding safety: HW flow rate is reduced if CW supply fails (and vice versa). Stable temperature regardless of pressure and flow rate variations in the system. Securitouch thermal insulation prevents burns. Thermal shocks are possible without removing the control lever or shutting off the cold water supply. Mixer body with smooth interior and very low water volume (reduces bacterial development). Flow rate limited to 4 lpm at 3 bar. Solid control lever. Ergonomic pop-up waste 1 1/4" in brass. F3/8" PEX flexibles with rotating unions, filters and non-return valves. Fixing reinforced via two stainless steel rods. Mechanical mixer with SECURITHERM pressure-balancing ideal for healthcare facilities, retirement and care homes, hospitals and clinics. Single hole mixer suitable for people with reduced mobility. Mixer with 30-year warranty.





## TECHNICAL CHARACTERISTICS

**SECURITHERM EP BIOSAFE pressure-balancing basin mixer - Ref. 2620MINIEP**

Connector	F3/8"
Technology	SECURITHERM EP BIOSAFE mechanical mixer
Drop height	50mm
Spout length	80mm
Flow rate	4 lpm at 3 bar
Temperature limiter	Yes
Norms	   
Warranty	



## ADVANTAGES

-  HW flow rate reduced if CW fails
-  Maximum hygiene: mixer with no spout
-  Thermal shocks are possible without removing lever
-  Hygiene: mixer body with very low water volume

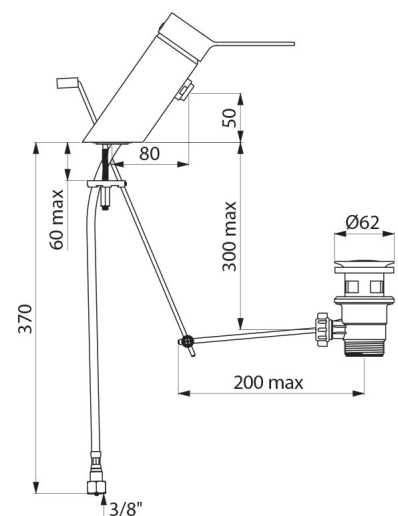

---

Repairability

