

SECURITHERM thermostatic sink mixer set

Ref. H9613

Sequential mixer and column set



DESCRIPTION

SECURITHERM thermostatic sink mixer set - Ref. H9613

SECURITHERM thermostatic sequential sink mixer set and column with retracting hand spray.
 Ideal for baby baths.
 Anti-scalding failsafe: shuts off automatically if cold or hot water supply fails.
 Securitouch thermal insulation prevents burns.
 Sequential: opens and closes with cold water.
 No risk of cross flow between the hot and cold water.
 No non-return valves on the inlets.
 Swivelling column H. 195mm L. 215mm.
 Retracting hand spray with 2 jet options: flow straightener/rain effect.
 Scale-resistant thermostatic sequential cartridge for single control temperature and flow-rate adjustment.
 Temperature can be adjusted from cold water to 40°C with maximum temperature limiter set at 40°C.
 Body and column with smooth interiors.
 Flow rate regulated at 7 lpm.
 No manual contact thanks to Hygiene control lever L. 100mm.
 Mixed water brass outlet L. 160mm.
 BIOSAFE flexible shower hose reduces bacterial proliferation: transparent polyurethane, smooth interior and exterior.
 Hose with narrow diameter (internal Ø 6mm): low water volume.
 Specific counterweight.
 PEX flexibles F3/8" and reinforced fixing via 2 stainless steel rods.
 Ideal for healthcare facilities, retirement and care homes, hospitals and clinics.
 Suitable for people with reduced mobility.
 30-year warranty.





TECHNICAL CHARACTERISTICS

SECURITHERM thermostatic sink mixer set - Ref. H9613

Connector	F3/8"
Technology	SECURITHERM sequential Securitouch
Drop height	195mm
Spout length	215mm
Flow rate	7 lpm
Temperature limiter	40°C
Finish	Chrome-plated brass
Norms	ACS  



ADVANTAGES

-  Sequential: opens/closes with cold water
-  Hygiene: no non-return valves
-  SECURITHERM: Optimal anti-scalding safety
-  Sequential open and closing on cold water

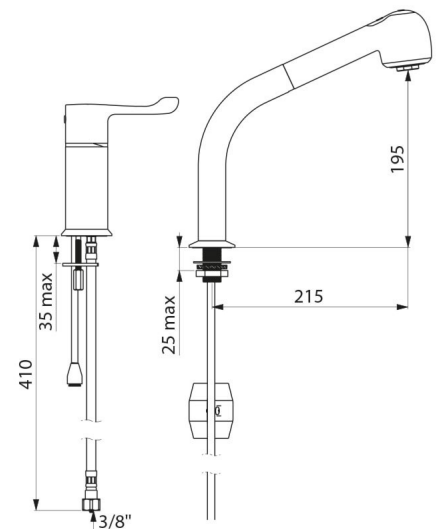

Warranty



Repairability

