

# SECURITHERM thermostatic sink mixer

Ref. H9612

Single hole thermostatic mixer with retracting hand spray



## DESCRIPTION

**SECURITHERM thermostatic sink mixer - Ref. H9612**

Deck-mounted SECURITHERM thermostatic basin mixer, ideal for baby baths. Sequential thermostatic mixer: opens and closes with cold water. No risk of cross flow between the hot and cold water. No non-return valves on the inlets. Anti-scalding failsafe: immediate shut-off if cold or hot water supply fails. Securitouch thermal insulation prevents burns. Single hole mixer with swivelling outlet H. 105mm L. 200mm. Sequential mixer with retracting hand spray with 2 jet options: flow straightener/rain effect. Scale-resistant sequential thermostatic cartridge for sequential control of the flow rate and temperature. Temperature control from cold water up to 40°C with maximum temperature limiter set at 40°C. Body with smooth interior. Flow rate regulated at 3 lpm. No manual contact thanks to Hygiene control lever L. 100mm. BIOSAFE flexible shower hose reduces bacterial proliferation: transparent polyurethane, smooth interior and exterior. Flexible with narrow interior Ø 6mm: low water volume. Specific counterweight. PEX flexibles F3/8". Fixing reinforced by 2 stainless steel rods. Thermostatic mixer ideal for healthcare facilities, retirement and care homes, hospitals and clinics. Mixer suitable for people with reduced mobility. 30-year warranty.





## TECHNICAL CHARACTERISTICS

**SECURITHERM thermostatic sink mixer - Ref. H9612**

Connector	F3/8"
Technology	SECURITHERM Securitouch sequential mixer
Drop height	105mm
Spout length	200mm
Flow rate	3 lpm
Temperature limiter	Yes
Finish	Chrome-plated brass
Norms	ACS  



## ADVANTAGES

-  Sequential: opens/closes with cold water
-  Hygiene: no non-return valves
-  SECURITHERM: Optimal anti-scalding safety
-  Hygiene: transparent flexible with smooth interior

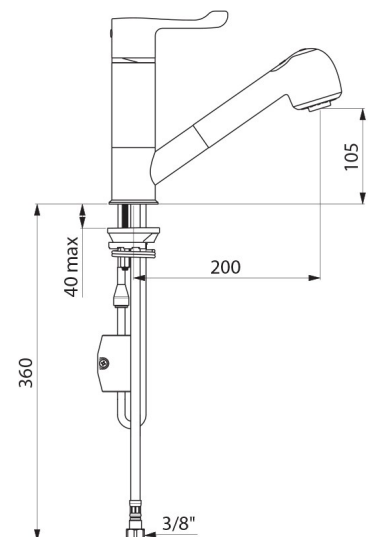

---

Warranty



---

Repairability

