

TEMPOMATIC tap with BIOCLIP spout

Ref. 20804T2

Electronic wall-mounted tap with stainless steel spout







DESCRIPTION

TEMPOMATIC tap with BIOCLIP spout - Ref. 20804T2



Wall-mounted electronic basin tap for mounting on panels.
 Electronic tap with BIOCLIP removable spout
 Infrared tap supplied with 2 removable BIOCLIP stainless steel spouts L. 129mm.
 Independent IP65 electronic control unit.
 230/12V mains supply with transformer.
 Base and spout with smooth interiors (reduces bacterial development).
 Adjustable duty flush (pre-set at ~60 seconds every 24 hours after last use).
 Flow rate limited to 4 lpm at 3 bar.
 Shock-resistant infrared presence detection sensor.
 Separate sensor for mounting on panels.
 M3/8" solenoid valve with integrated filter.
 Ø 60mm chrome-plated brass base.
 Anti-blocking security.
 Recommended installation height: 110 - 200mm above the basin surface.
 Electronic tap suitable for use in healthcare facilities, retirement and care homes, hospitals and clinics.
 Electronic tap suitable for people with reduced mobility.
 30-year warranty.
 Two shut-off options:
 - standard mode: timed flow with automatic shut-off.
 - ON/OFF mode: user shuts off flow voluntarily or automatic shut-off after 30 minutes of flow.
 Thermal shocks are possible.
 Mount the sensor beside the tap in the ON/OFF mode.

ADVANTAGES

-  Automatic duty flush limits bacterial development
-  Hygiene: spout can be removed and descaled inside
-  Hygiene: smooth interior reduces bacteria
-  No manual contact: infrared sensor

TECHNICAL CHARACTERISTICS

TEMPOMATIC tap with BIOCLIP spout - Ref. 20804T2

Connector	3/8"
Technology	Wall-mounted electronic tap
Depth	190mm
Length	129mm
Spout length	188mm
Flow rate	4 lpm at 3 bar
Finish	Chrome-plated brass
Norms	ACS CE   

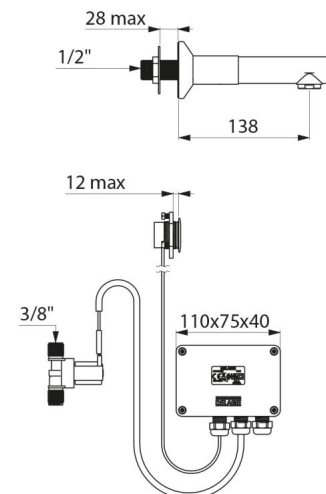

Warranty



Repairability

