

# Shower kit with thermostatic mixer

Ref. H9741SKIT

Shower kit with thermostatic mixer





## DESCRIPTION

**Shower kit with thermostatic mixer - Ref. H9741SKIT**





Shower riser rail with thermostatic dual control mixer.  
 Shower kit with SECURITHERM thermostatic shower mixer.  
 Mixer with anti-scalding failsafe: shuts off automatically if cold water supply fails.  
 Prevents cold showers: shuts off automatically if hot water supply fails.  
 Securitouch thermal insulation prevents burns.  
 Scale-resistant thermostatic cartridge adjusts the temperature.  
 ¼-turn ceramic valve head adjusts the flow rate.  
 Temperature control from 25°C up to 41°C.  
 Double temperature limiter: 1st limiter set at 38°C, 2nd limiter set at 41°C.  
 Thermal shocks are possible without removing the control knob or shutting off the cold water.  
 Flow rate regulated at 9 lpm.  
 Chrome-plated body and ERGO controls.  
 M1/2" shower outlet.  
 Filters and non-return valves integrated in the inlets, F3/4".  
 Mixer with offset standard wall connectors.  
 • Sliding shower head holder (ref. 813) on a chrome-plated riser rail (ref. 821) with soap dish and flexible shower hose (ref. 836T1).  
 • Shower head retaining collar (ref. 830).  
 Mixer ideal for healthcare facilities, retirement and care homes, hospitals and clinics  
 Mixer suitable for people with reduced mobility.  
 Shower kit with 30-year warranty.

## TECHNICAL CHARACTERISTICS

**Shower kit with thermostatic mixer - Ref. H9741SKIT**

Connector	M1/2"
Technology	SECURITHERM Securitouch thermostatic mixer,
Depth	84mm
Length	286mm
Flow rate	9 lpm
Temperature limiter	Yes
Finish	Chrome-plated brass
Norms	ACS 
Warranty	

## ADVANTAGES

-  SECURITHERM: Optimum anti-scalding safety
-  Double maximum temperature limiter
-  Securitouch thermal insulation prevents burns
-  Thermostatic: total temperature stability

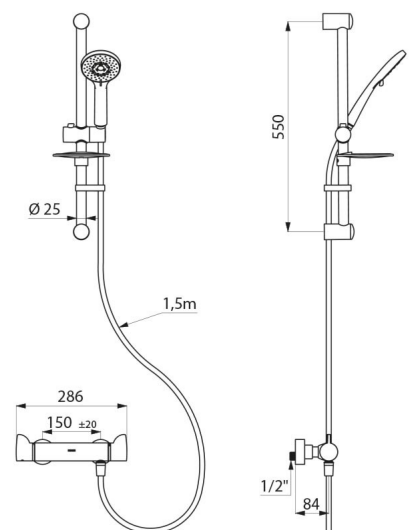

---

Repairability

