

Auto-draining shower kit with thermostatic mixer

Ref. H9630HYG

Thermostatic sequential mixer with no non-return valves



DESCRIPTION



Auto-draining shower kit with thermostatic mixer - Ref. H9630HYG

SECURITHERM thermostatic sequential shower kit with auto-draining device.





- Mixer with scale-resistant, thermostatic sequential cartridge: Thermostatic sequential mixer: opens and closes with cold water. Mixer with no non-return valves on the inlets (reduces bacterial proliferation). No risk of cross flow between hot and cold water. Sequential mixer with anti-scalding failsafe: shuts off automatically if cold or hot water supply fails. Securitouch thermal insulation prevents burns. Temperature control from cold water up to 39°C with maximum temperature limiter set at 39°C. Thermal shocks are possible. Body with smooth interior and low water volume. Flow rate regulated at 9 lpm. Chrome plated brass body and Hygiene lever L. 100mm. M1/2" bottom shower outlet. Wall-mounted mixer with offset STOP/CHECK connectors, M1/2" M3/4". Mixer ideal for healthcare facilities, retirement and care homes, hospitals and clinics.
- Shower head (ref. 813) with flexible shower hose (ref. 836T3) and adjustable, chrome-plated wall-mounted support (ref. 845).
- Auto-draining device FM1/2" for installation between the flexible hose and the shower head, automatically drains the shower head and flexible hose (reduces bacterial development) (ref. 880). Suitable for people with reduced mobility. 30-year warranty.

TECHNICAL CHARACTERISTICS

Auto-draining shower kit with thermostatic mixer - Ref. H9630HYG

Connector	M1/2"
Technology	SECURITHERM single control, Securitouch
Depth	185mm
Length	184mm
Flow rate	9 lpm
Temperature limiter	39°C
Finish	Chrome-plated brass
Norms	ACS 
Warranty	

ADVANTAGES

-  Sequential: opens/closes with cold water
-  Maximum hygiene: no non-return valves
-  No non-return valve.
-  Opens and closes via single control lever

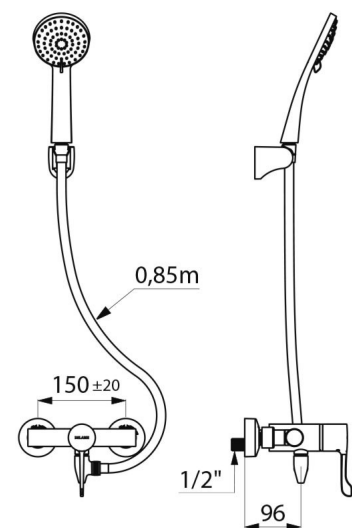

Repairability

