

Mechanical mixer with retracting hand spray

Ref. 2211

Single hole mechanical mixer with retracting hand spray



DESCRIPTION

Mechanical mixer with retracting hand spray - Ref. 2211

Deck-mounted mechanical sink mixer with retracting hand spray suitable for baby baths.
 Single hole mixer with retracting hand spray and swivelling spout H. 105mm L. 200mm.
 Ø 40mm standard ceramic cartridge with pre-set maximum temperature limiter.
 Securitouch thermal insulation prevents burns.
 Mechanical mixer with retracting hand spray with 2 jet options: flow straightener/rain effect.
 Body with smooth interior.
 Flow rate limited to 7 lpm at 3 bar.
 Chrome-plated brass body and solid control lever.
 BIOSAFE flexible shower hose reduces bacterial proliferation: transparent polyurethane flexible hose ensures replacement if biofilm is present, smooth interior and exterior.
 Narrow flexible (interior Ø 6mm), low water volume.
 Specific counterweight.
 PEX flexibles F $\frac{3}{8}$ ".
 Fixing reinforced by 2 stainless steel rods.
 Mechanical mixer ideal for healthcare facilities, retirement and care homes, hospitals and clinics.
 Single hole mixer suitable for people with reduced mobility.
 30-year warranty.





TECHNICAL CHARACTERISTICS

Mechanical mixer with retracting hand spray - Ref. 2211

Connector	F3/8"
Height	162mm
Drop height	105mm
Spout length	200mm
Flow rate	7 lpm at 3 bar
Temperature limiter	Yes
Finish	Chrome-plated brass
Norms	ACS  
Warranty	



ADVANTAGES

-  Hygiene: transparent hose with smooth interior
-  Ergonomic: solid lever is easy to grip
-  Comfort: retracting hand spray with 2 jet options
-  Securitouch: thermal insulation prevents burns

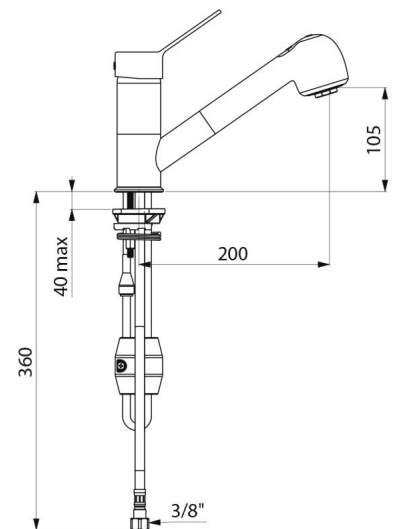

Repairability

