

SECURITHERM BIOCLIP thermostatic sink mixer

Ref. H9610

Wall-mounted thermostatic sequential mixer







DESCRIPTION

SECURITHERM BIOCLIP thermostatic sink mixer - Ref. H9610



Wall-mounted thermostatic sink mixer.
 Thermostatic sequential mixer: opens and closes with cold water.
 No risk of cross flow between hot and cold water.
 No non-return valves on the inlets.
 Wall-mounted thermostatic mixer supplied with 1 removable disposable spout made from recyclable Hostaform® L. 125mm.
 Anti-scalding failsafe: shuts off automatically if cold or hot water supply fails.
 Securitouch thermal insulation prevents burns.
 Scale-resistant thermostatic sequential cartridge for sequential control of flow rate and temperature.
 Temperature can be adjusted from cold water up to 40°C with maximum temperature limiter set at 40°C.
 Thermal and chemical shocks are possible.
 Body and spout with smooth interiors and low water volume.
 Flow rate regulated at 7 lpm.
 Chrome-plated brass body.
 No manual contact thanks to Hygiene control lever L. 146mm.
 Mixer with 150mm centres supplied with offset STOP/CHECK connectors M1/2" M3/4" suitable for hospitals.
 Thermostatic mixer ideal for healthcare facilities, retirement and care homes, hospitals and clinics.
 Sequential mixer suitable for people with reduced mobility.
 30-year warranty.

ADVANTAGES

-  Sequential: opens/closes with cold water
-  Maximum hygiene: no non-return valves
-  Removable spout: reduces bacterial development
-  SECURITHERM: optimum anti-scalding safety

TECHNICAL CHARACTERISTICS

SECURITHERM BIOCLIP thermostatic sink mixer - Ref. H9610

Connector	M1/2"
Technology	SECURITHERM Securitouch sequential mixer
Height	141mm
Width	184mm
Spout length	185mm
Flow rate	7 lpm
Temperature limiter	Yes
Finish	Chrome-plated brass
Norms	ACS  

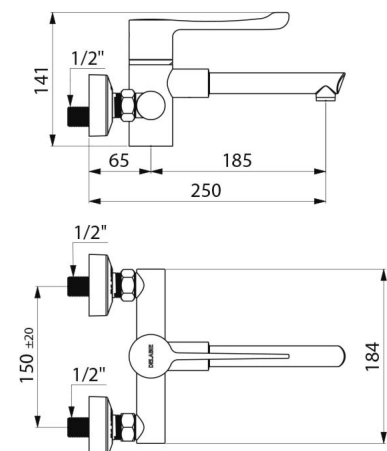

Warranty

